

R&S®TLV9 | R&S®TLU9 LOW-POWER VHF/UHF TRANSMITTER AND GapFiller FAMILY

Powerful, reliable, smart

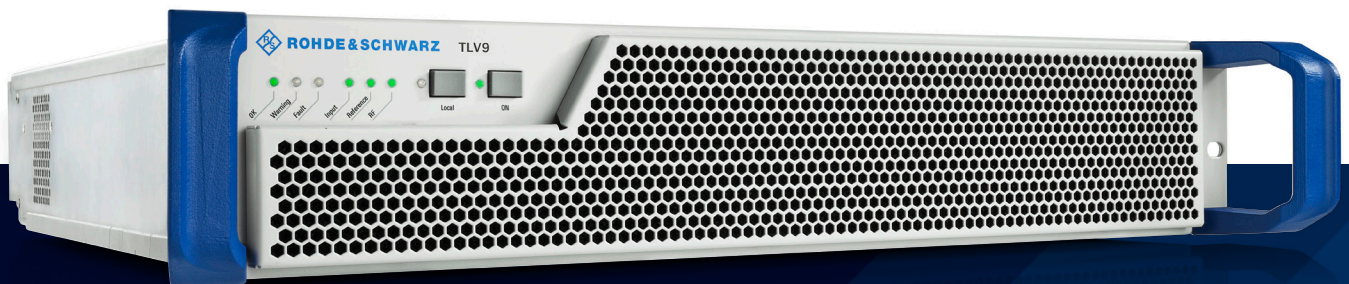

Product Brochure
Version 08.00

AT A GLANCE

From commissioning to servicing, the R&S®TLV9/R&S®TLU9 Transmitter and GapFiller family offers the highest reliability, ensuring troublefree operation during the transmitters' lifetime. Sophisticated design and the use of premium RF components result in maximum availability, with the highest MTBF values on the market.

The R&S®TLx9 family comprises the R&S®TLV9 Low-Power VHF Transmitter for DAB+ and digital TV applications and the R&S®TLU9 Low-Power UHF Transmitter and GapFiller for digital TV applications.

The compact R&S®TLU9 digital TV Transmitter and GapFiller delivers COFDM output power of up to 200 W from a single box. The R&S®TLV9 operates in VHF band III and delivers output power of up to 300 W, likewise from a single box. It is mainly intended for DAB+ applications but can in some regions also be used for digital TV broadcasting.

The R&S®TLV9 and R&S®TLU9 come with state-of-the-art features such as adaptive digital predistortion and TSoIP feeding. The R&S®TLU9 GapFiller makes gap filling effortless and straightforward with the unique R&S®smartEC feature, a built-in intelligent echo cancellation mechanism for continuous adaptation to changing echo scenarios.

A comprehensive range of options is also available, including terrestrial and satellite receivers, components for redundancy configurations and an exciter backup battery, all accommodated in a single box (2 RU for the R&S®TLV9 and 1 RU or 2 RU for the R&S®TLU9). A 7" touchscreen GUI for fast, intuitive operation rounds out the choice of options. All these features make this powerful transmitter and gap filler family a highly attractive solution for network operators.

The R&S®TLV9 and R&S®TLU9 are members of the successful R&S®Tx9 transmitter generation. They save energy and minimize total cost of ownership (TCO) thanks to the highest efficiency in their power class and straightforward serviceability. Network operators benefit from a significant reduction in operating expense (OPEX) throughout the transmitters' lifetime.

What makes the R&S®TLV9/R&S®TLU9 unique is the combination of outstanding features in a single box and on a common platform.

**BEST SERVICEABILITY +
HIGHEST QUALITY AND PERFORMANCE +
LOWEST OPERATING EXPENSE**

Key facts

- ▶ Most compact low-power transmitters and gap filler
- ▶ Highest availability in their power class
- ▶ Best serviceability in their class
- ▶ Up to 25% efficiency for the R&S®TLU9
- ▶ Up to 30% efficiency for the R&S®TLV9
- ▶ World-class echo cancellation with R&S®smartEC

BENEFITS

Smooth operation, robust and versatile

▶ page 4

Reliable and innovative

▶ page 6

Unparalleled gap filler performance

▶ page 8

Optimized in all operational aspects

▶ page 10

Easy to set up

▶ page 12

Ensured quality of service

▶ page 13

R&S®TLU9 2 RU model with
R&S®TDU901 transmitter display unit.

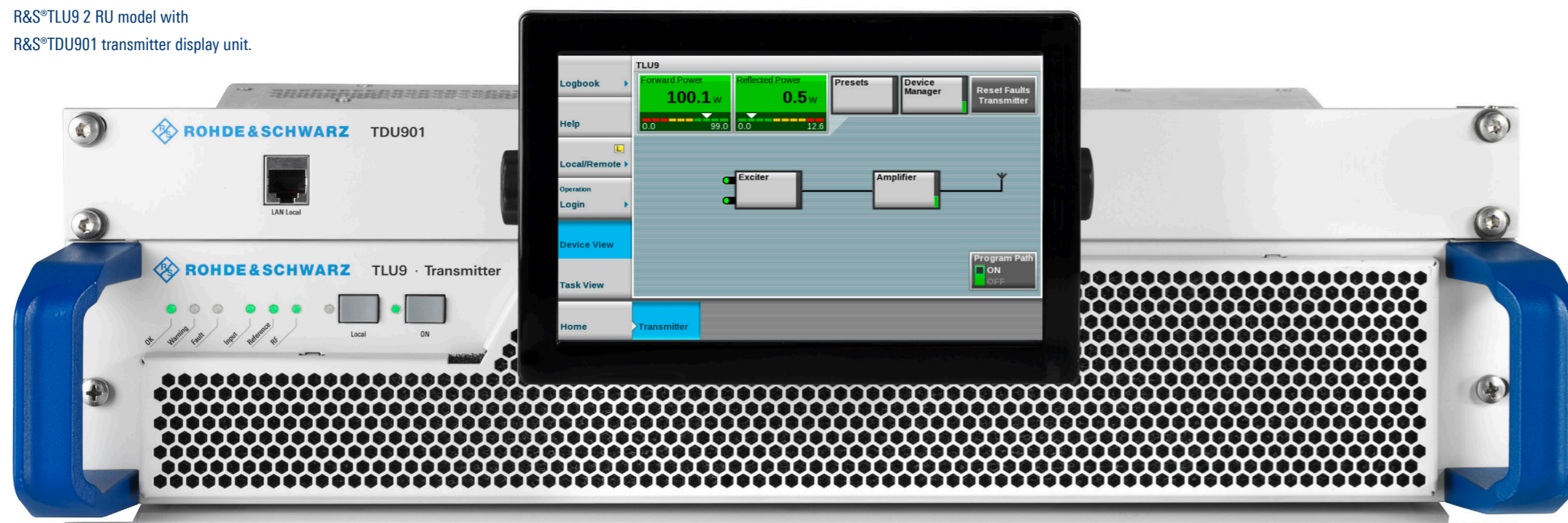

E5 – efficiency to the power of five

The R&S®Tx9 transmitter generation scores with efficiency at five different levels:

- ▶ **Efficiency in energy**
Economical: minimum power consumption for cost savings over system lifetime
- ▶ **Efficiency in space**
Space-saving: several transmitters and additional components in one rack
- ▶ **Efficiency in operation**
Smooth installation, operation and maintenance
- ▶ **Efficiency in configuration**
Customer-focused: modular solutions for flexible system configuration
- ▶ **Efficiency for a lifetime**
Future-ready: can be expanded to accommodate new standards and technologies



MODEL OVERVIEW

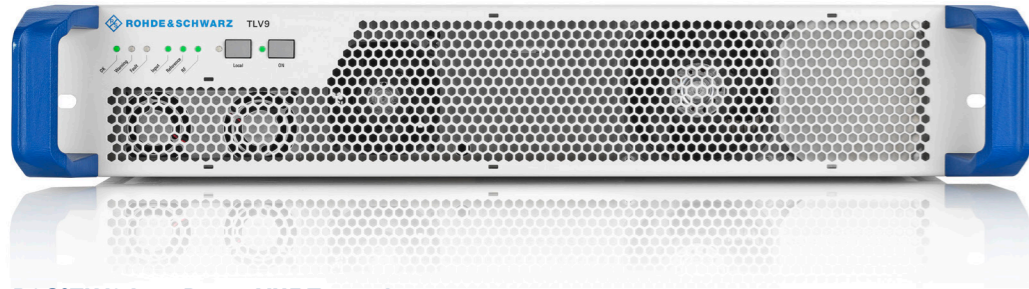

R&S®TLV9.

R&S®TLV9 Low-Power VHF Transmitter

	R&S®TLV9 2 RU model		
VHF DAB+ transmitter			
Output power (RMS) ¹⁾	50 W	150 W	300 W
VHF digital TV transmitter			
Output power (RMS) ¹⁾ for DVB-T2, DVB-T, ATSC1.0	50 W	150 W	300 W
Dimensions (W x H x D)	483 mm (19") x 88 mm (2 RU) x 450 mm (19 in x 3.46 in (2 RU) x 17.72 in)		

¹⁾ Before bandpass filter.

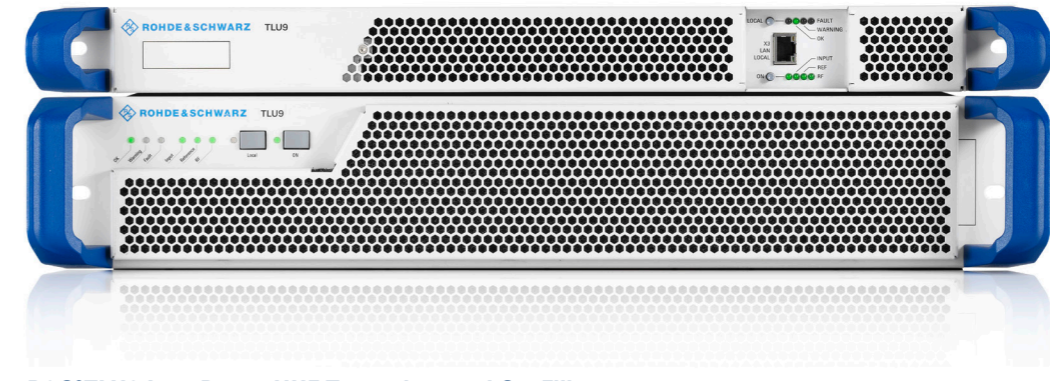

R&S®TLU9, 1 RU and 2 RU model.

R&S®TLU9 Low-Power UHF Transmitter and GapFiller

	R&S®TLU9 1 RU model			R&S®TLU9 2 RU model			
UHF digital TV transmitter							
Output power (RMS) ¹⁾ for DVB-T2, DVB-T, ISDB-T _B , DTMB, ATSC 1.0/ATSC 3.0	5 W	10 W	15 W	25 W	50 W	100 W	200 W
UHF digital TV gap filler							
Output power (RMS) ¹⁾ for DVB-T2, DVB-T, ISDB-T _B , ATSC 1.0/ATSC 3.0	5 W	10 W	15 W	25 W	50 W	100 W	200 W
Dimensions (W x H x D)	483 mm (19") x 44 mm (1 RU) x 600 mm (19 in x 1.73 in (1 RU) x 23.62 in)			483 mm (19") x 88 mm (2 RU) x 450 mm (19 in x 3.46 in (2 RU) x 17.72 in)			

¹⁾ Before bandpass filter.

SMOOTH OPERATION, ROBUST AND VERSATILE

Premium components and extremely robust design

The R&S®TLV9/R&S®TLU9 is the only transmitter product in its power class that offers superior quality. With premium RF components, an elaborate architecture and an extremely robust design, it provides unparalleled availability and long service intervals. Using state-of-the-art technology, the R&S®TLV9/R&S®TLU9 is the world's first transmitter to deliver TV signals based on direct digital RF generation. This feature contributes substantially toward maximum signal quality and stability. The R&S®TLV9/R&S®TLU9 provides reliability and smooth operation, keeping transmitter downtime to a minimum.

R&S®THU9evo experience in one or two rack units

Uniform operating concept for transmitters of the R&S®Tx9 generation

The R&S®TLV9/R&S®TLU9 comes with a status display, a remote/local switch and an RF on/off switch on the front panel. An optional transmitter display unit (R&S®TDU901) with a 7" touchscreen is available for fast, intuitive operation of the R&S®TLV9/R&S®TLU9. The standard Ethernet port makes it possible to operate the transmitter (and gap filler) via a web interface, either locally or remotely, or to integrate it into a network management system via SNMP.

Whether via touchscreen or web interface – the user benefits from the same convenient GUI used throughout the R&S®Tx9 transmitter generation. That means that if multiple different transmitters from the R&S®Tx9 generation are used in a network, the uniform GUI significantly reduces training effort for operating personnel.

IP transport stream feed reduces infrastructure costs

Due to its cost-effectiveness, IP technology is also gaining ground in broadcast networks. In addition to ASI interfaces, the R&S®TLV9/R&S®TLU9 offers two optional Gigabit Ethernet interfaces for the redundant feed of two transport streams. External IP-to-ASI gateways are no longer necessary. The TSoIP functionality is monitored by the transmitter itself. No extra hardware is required, so this solution saves money and space and simplifies program feed monitoring.

Built-in signal analysis

The R&S®TLV9/R&S®TLU9 has an integrated signal analysis function that continuously measures and outputs shoulder distance and MER values. Operators benefit from this feature as they can monitor signal quality without having to invest in additional measuring equipment.

Smart optioning system

The R&S®TLV9/R&S®TLU9 comes with a unique optioning system, making it possible to integrate optional hardware components such as a satellite receiver, DTV receiver (DVB-T/DVB-T2, ATSC 1.0) or components for redundancy configurations within the transmitter housing. This eliminates the need for additional equipment, saving space and cost and simplifying operation, since these hardware components are controlled and monitored by the R&S®TLV9/R&S®TLU9. The transmitter has free slots to accommodate hardware options for expanded functionality.

RELIABLE AND INNOVATIVE

Integrated exciter backup battery bridges voltage drops

The R&S®TLV9/R&S®TLU9 comes with an optional, integrated exciter backup battery, a feature that is unique on the low-power transmitter market. The battery minimizes the negative effects of mains voltage interruptions. It powers the CPU and the signal processing components during voltage interruptions, preventing a reboot of the transmitter for interruptions of up to 10 seconds. The battery thus reduces off-the-air time, offering an economical alternative to using an uninterruptible power supply (UPS).

Innovative redundancy configurations

The R&S®TLV9/R&S®TLU9 offers two different redundancy configurations:

- ▶ BackupTx
- ▶ Compact N+1

In a BackupTx system, two R&S®TLV9 or R&S®TLU9 transmitters operate in a fully symmetrical 1+1 configuration. The two units monitor each other, making extra hardware for system monitoring and control unnecessary. Doing away with a separate, governing control unit eliminates the risk of a single point of failure.

The BackupTx configuration offers the functionality and convenience of a classic passive standby configuration and also increases the availability of transmitter functionality. BackupTx systems require considerably less space than conventional transmitter backup configurations, a major advantage when space is at a premium.

If an active transmitter fails, the standby transmitter takes over without any interruption of transmission. The same applies in the event a standby transmitter needs to be replaced. The new standby transmitter reads the settings from the active transmitters, which continue operating.

Compact N+1 is an enhanced version of the well-known N+1 configuration. Same as BackupTx, Compact N+1 requires no extra hardware for system monitoring and control. These functions are performed by the standby transmitter. The standby transmitter in a Compact N+1 configuration, same as the passive transmitter in a BackupTx configuration, is automatically adjusted to the settings of the active transmitters.

The transmitters of the R&S®TLx9 family have free slots to accommodate hardware options for expanded functionality.

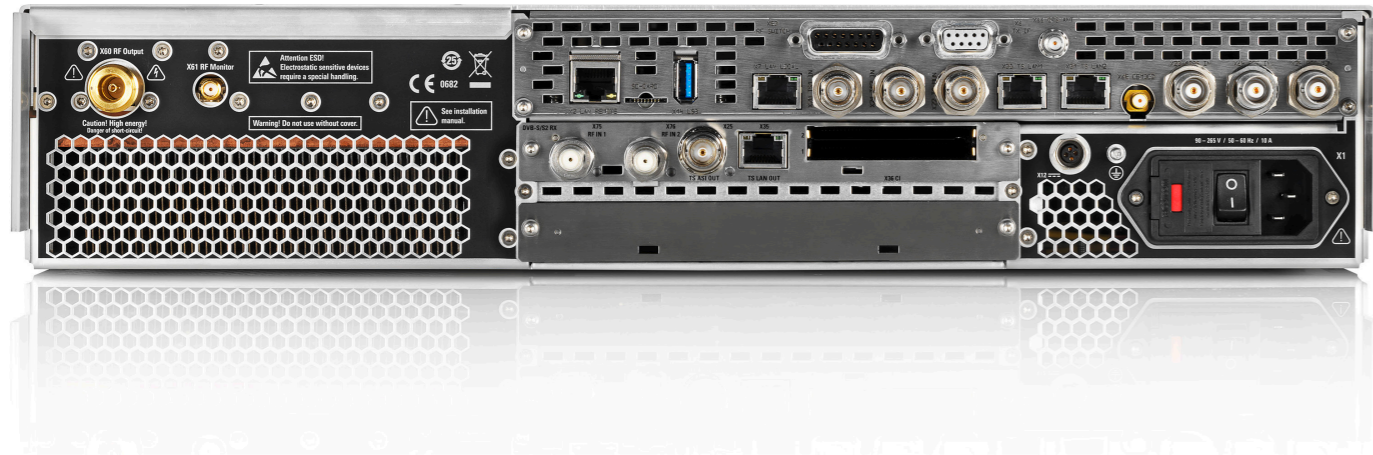

Interfaces of the R&S®TLU9 1 RU model.



R&S®TLV9/R&S®TLU9 compact N+1 redundancy configuration

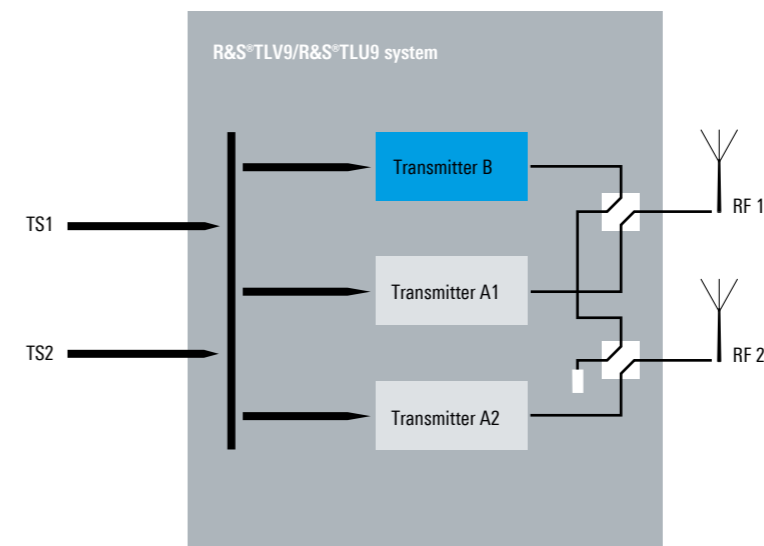

UNPARALLELED GAP FILLER PERFORMANCE

The R&S®TLU9 is also ideal for rebroadcasting applications both in single-frequency and multifrequency networks. To meet network operators' needs, Rohde&Schwarz has designed a product that combines the strengths and benefits of the R&S®TLU9 transmitter with pioneering and unique technologies to deliver unparalleled rebroadcasting performance. The result is the R&S®TLU9 GapFiller.

Conventional gap fillers are complex to configure. They only work well under specific reception conditions and cannot handle changing echo scenarios. The R&S®TLU9 GapFiller addresses all these limitations. It offers network operators the optimum combination of top signal quality, maximum reliability and minimum operating expense.

Furthermore, it is the first gap filler to feature R&S®smartEC, a built-in intelligent echo cancellation mechanism for self-configuration and automatic adaptation of the transmitter to changing echo conditions.

Integrated input filter

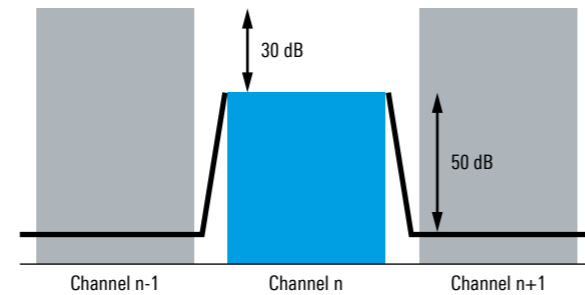

Integrated input filter minimizes out-of-channel influences

As a product for rebroadcasting applications, the R&S®TLU9 GapFiller was engineered to perform excellently in challenging adjacent channel situations. It features an integrated input filter that suppresses adjacent channels by 80 dB. The filter is located very early in the signal processing path to prevent adjacent channel emissions from affecting the processing of the wanted signal. The integrated input filter has extremely sharp edges (80 dB at ± 4.115 MHz), delivering a crystal-clear signal unimpaired by unwanted emissions and eliminating the need for an external input filter.

THE R&S®TLU9 GapFiller OFFERS THE FOLLOWING ADVANTAGES

It addresses both the commercial and technical needs of network operators by providing maximum signal quality under any echo conditions.

It can cancel very strong echoes and offers continuously high signal quality and stability even in challenging echo scenarios. This is achieved through continuous, automatic adaptation to changing echo situations.

Plus, the R&S®TLU9 GapFiller offers high robustness against strong adjacent-channel power levels.

With maximized signal quality, minimal impact of ambient and out-of-channel conditions on MER degradation and self-configuring echo cancellation settings, the R&S®TLU9 GapFiller provides reliable signal transmission and enables deterministic planning of gap filler performance while minimizing OPEX.

Echo cancellation performance

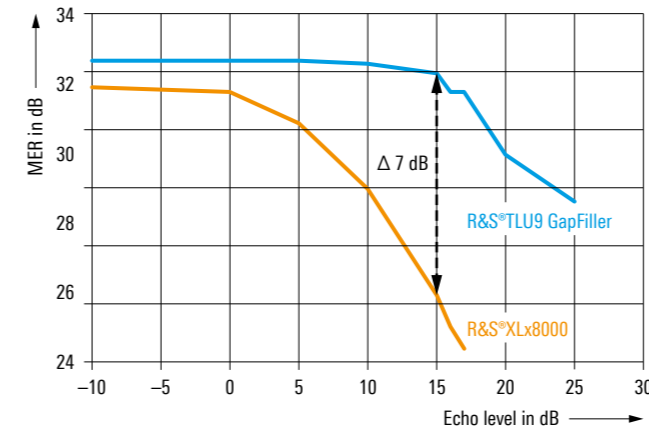

World-class echo cancellation for excellent signal quality

The R&S®TLU9 GapFiller comes with unparalleled echo cancellation performance. Not only does it stably cancel even very high echo levels of up to 25 dB. It also provides powerful Doppler echo cancellation and the ability to handle multiple echoes – always focusing on highly reliable operation and excellent signal quality (MER), which are both of utmost importance for network operators.

The R&S®TLU9 GapFiller offers significant improvements over the previous product generation (R&S®XLx8000) in all echo scenarios. The diagram on the previous page compares the echo cancellation performance of both products with respect to the achieved MER. For echo levels of up to 15 dB, the R&S®TLU9 shows no significant MER degradation. Instead, it achieves a 7 dB higher MER than the previous transposer generation, i.e. for echoes up to 15 dB, the R&S®TLU9 GapFiller eliminates the effects of echoes on the signal quality.

Continuous self-optimization with R&S®smartEC

MER for Doppler echoes

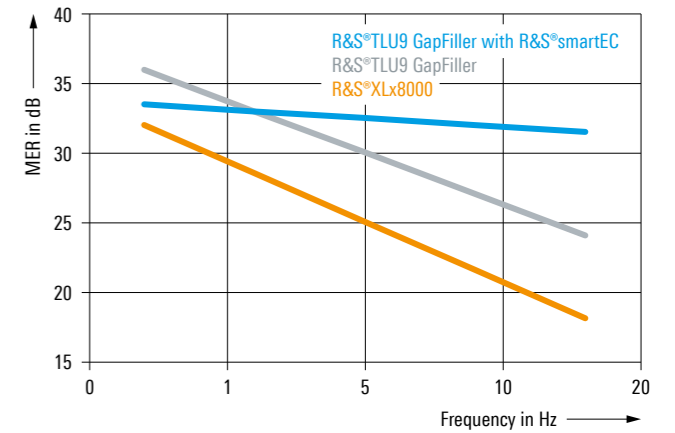

R&S®smartEC – continuous self-optimization for significantly reduced OPEX

Former gap filler products delivered unpredictable signal quality in complex and changing echo scenarios. This required manual signal quality optimization, resulting in high operating expense. The R&S®TLU9 GapFiller addresses these technical and commercial challenges with the unique R&S®smartEC feature, which pays off especially in networks with a high number of gap fillers.

With R&S®smartEC, the R&S®TLU9 GapFiller intelligently adapts its echo cancellation settings to varying echo situations, continuously and in real time. It provides significantly better signal quality for changing echo conditions and Doppler echo scenarios.

MER degradation caused by echo cancellation is continuously minimized for all echo paths. R&S®smartEC provides the required echo suppression with the lowest possible noise contribution. It minimizes the need for manual reconfiguration of the echo cancellation settings. Regular site visits by technicians are no longer necessary. This significantly reduces the costs for operating a gap filler network.

OPTIMIZED IN ALL OPERATIONAL ASPECTS

Highest availability at minimum operating costs

Given the large number of units contained in low-power transmitter and gap filler networks, network operators focus on availability and service costs, as these are the key factors determining operating expenses. The R&S®TLV9/R&S®TLU9 was developed with maximum availability and long service intervals in mind. It also delivers clear diagnostic information in the event of a fault, enabling efficient, targeted troubleshooting.

Like all transmitters of the R&S®Tx9 generation, the R&S®TLV9/R&S®TLU9 can be monitored and controlled as a fleet using modern broadcast network management systems (NMS). The R&S®TLV9/R&S®TLU9 comes with an SNMP interface with extensive capabilities, allowing even complex operating procedures to be implemented as automatic routines.

High efficiency

Despite its low output power, the R&S®TLV9/R&S®TLU9 offers outstanding efficiency, with a significant impact on operating expenses due to the fleet sizes employed in low-power transmitter and gap filler networks. The R&S®TLU9 achieves up to 25% efficiency for COFDM standards, setting the benchmark in the low-power transmitter class. The R&S®TLV9 reaches up to 30% efficiency for output powers up to 300 W in DAB+, DVB-T/T2 and ATSC mode. These excellent figures are attributable to the company's consistent effort toward innovation in the development of cost-optimized low-power transmitters, as well as to the pioneering efficiency optimization feature developed by Rohde & Schwarz.

As a result, the R&S®TLV9 and R&S®TLU9 cut energy costs by more than 25%, outperforming conventional transmitters and gap fillers in this power class that offer only average efficiency.

Designed for low service costs

The R&S®TLV9/R&S®TLU9 has been designed for minimum maintenance, calibration and testing effort in line with user requirements. Servicing is simple and straightforward, whether on site or at a Rohde & Schwarz service center, significantly reducing operating expenses for low-power transmitter and gap filler networks.

300 W in only two rack units

Apart from energy and service costs, infrastructure costs account for a large proportion of the expenses incurred during a transmitter's lifecycle. The R&S®TLU9 delivers up to 200 W and the R&S®TLV9 up to 300 W of output power in just two rack units. The exceptionally compact size is another cost-cutting factor, which has been achieved through high integration density of the signal generation and transmitter control components and a well thought-out cooling concept. Moreover, diverse options can be integrated in the R&S®TLV9/R&S®TLU9 for an even smaller footprint. Users benefit from a highly compact, powerful transmitter and gap filler with densely packed features that satisfies the most stringent demands in terms of functionality, reliability and availability.

Enhanced ATSC translator features for easier deployment

When deployed as an ATSC translator, the R&S®TLV9/R&S®TLU9 offers enhanced features to make operators' lives easier.

With the PSIP editing option, the R&S®TLV9/R&S®TLU9 detects and displays the original TSID and PSIP information in real time. If desired, the translator can modify the contents of the PSIP table, including short name and major and minor channel number of the input stream. It can also forward all dynamic PSIP electronic program guide information without corrupting any data. With this feature integrated in the R&S®TLV9/R&S®TLU9, no additional external device is needed for PSIP editing, and deployment is made easier.

Upon loss of all inputs (ASI and/or RF tuner input), a static picture can be displayed instead of a blue screen. The transmitter will continuously loop a standard compliant transport stream. The static picture feature can deliver a viewer message. This feature provides a fallback, enabling the transmitter to stay on air if no input signal is present and helping operators to keep and inform their viewers.

When operating as a translator, the R&S®TLV9/R&S®TLU9 supports loopthrough of the ASI signal. This enables the transmitter to demodulate the RF input signal, allowing the operator to monitor the incoming ASI signal at the base-band level. An ASI test system or ASI transport stream reader can analyze the decoded RF input signal via the ASI output port. This helps simplify the system design of translator stations and gain insight into the root cause of any problems that may occur.

Energy savings with the R&S®TLV9/R&S®TLU9

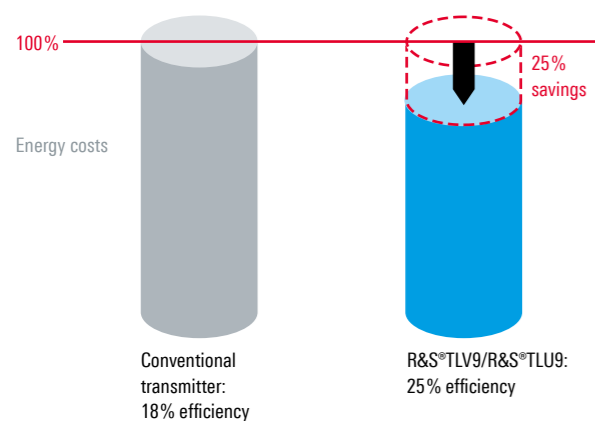

Adjust PSIP information easily without the need for additional devices

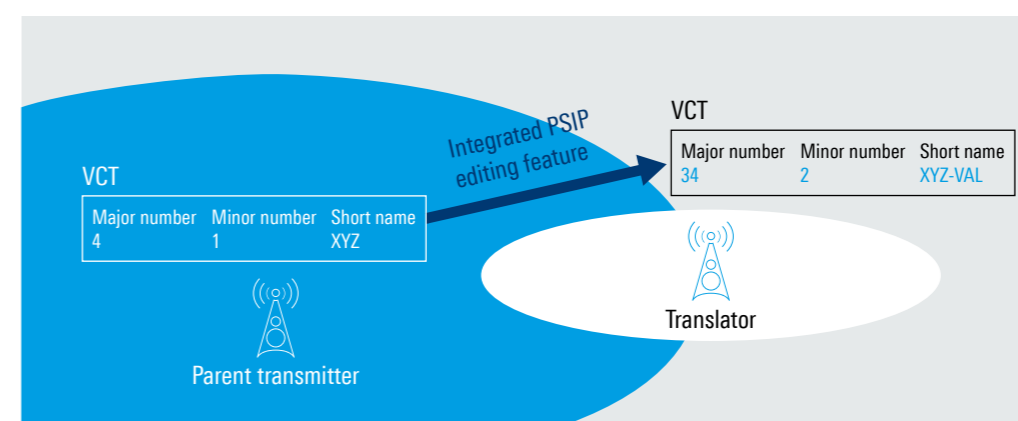

EASY TO SET UP

Convenient graphical user interface

The R&S®TLV9/R&S®TLU9 offers network operators the convenience they want and need when installing, commissioning and operating transmitters. The sophisticated graphical user interface (GUI) shows the transmitter and gap filler status at a glance.

The GUI offers, among other things, a task-based and a device-based menu. The task-based menu displays the different tasks that can be performed with the transmitter and/or gap filler. The tasks and their individual steps are presented in a well-structured layout, so that they can be accomplished in a minimum of time. For example, when putting the transmitter or gap filler into operation, the operator is guided through the configuration of the different functional units and given help when entering parameters and changing settings.

The device-based menu provides a graphical view of the transmitter structure. The user simply touches a component to directly access its parameters.

Minimal infrastructure requirements, minimal footprint

Transmitters and gap fillers are excellent solutions to bridge the last mile in digital TV and DAB+ networks. With their low demands on broadcasting and IT infrastructures and minimal space requirements, the transmitters of the R&S®TLx9 family are ideal for use in environments that do not provide a typical transmitter site infrastructure.

The smart optioning system makes it possible to perfectly match the transmitters to the conditions and requirements of a specific site. For instance, the R&S®TLV9/R&S®TLU9 can be enhanced to receive transport streams via satellite.

The R&S®TLx9 transmitters can monitor ambient temperature and humidity, making it possible to verify that ambient conditions are within permissible limits to ensure a long service life. No extra equipment is required.

Self-optimizing for maximum efficiency

The R&S®TLV9/R&S®TLU9 offers adaptive digital predistortion for quick and easy linearization of the transmitter and gap filler. This superior feature was developed by Rohde&Schwarz to simplify frequency changes, and it does more than outperform frequency-specific, time-consuming manual linearization. Adaptive digital predistortion is the prerequisite for deploying the efficiency optimization feature, which adaptively optimizes transmitter efficiency, minimizing power consumption and thus energy costs. Thanks to this innovative feature, the R&S®TLV9 is able to transmit COFDM signals with up to 30% efficiency, and the R&S®TLU9 with up to 25% efficiency without the use of Doherty technology.

ENSURED QUALITY OF SERVICE

Install and forget

The R&S®TLV9/R&S®TLU9 is the only transmitter in its power class that offers superior quality. With premium RF components, an elaborate architecture and an extremely robust design, it provides unparalleled availability and long service intervals.

Reliability and smooth operation

Building on the knowledge and experience gained with previous product families, the R&S®TLV9/R&S®TLU9 low-power transmitter was developed with a focus on creating an even better and more robust transmitter. Using state-of-the-art technology, the R&S®TLV9/R&S®TLU9 achieves maximum signal quality and stability and ensures outstanding reliability and smooth operation, keeping transmitter downtime to a minimum.

Long product life

As a future-ready product, the R&S®TLV9/R&S®TLU9 is designed to save energy costs throughout its lifecycle with the Rohde&Schwarz efficiency optimization feature. In addition, based on a proven platform with premium RF components and a highly advanced thermal design, the R&S®TLV9/R&S®TLU9 is entirely focused on prolonged product life. The transmitter and gap filler is an excellent solution for bridging the last mile in digital TV and DAB+ networks.

The user simply touches a transmitter component to directly access its parameters.

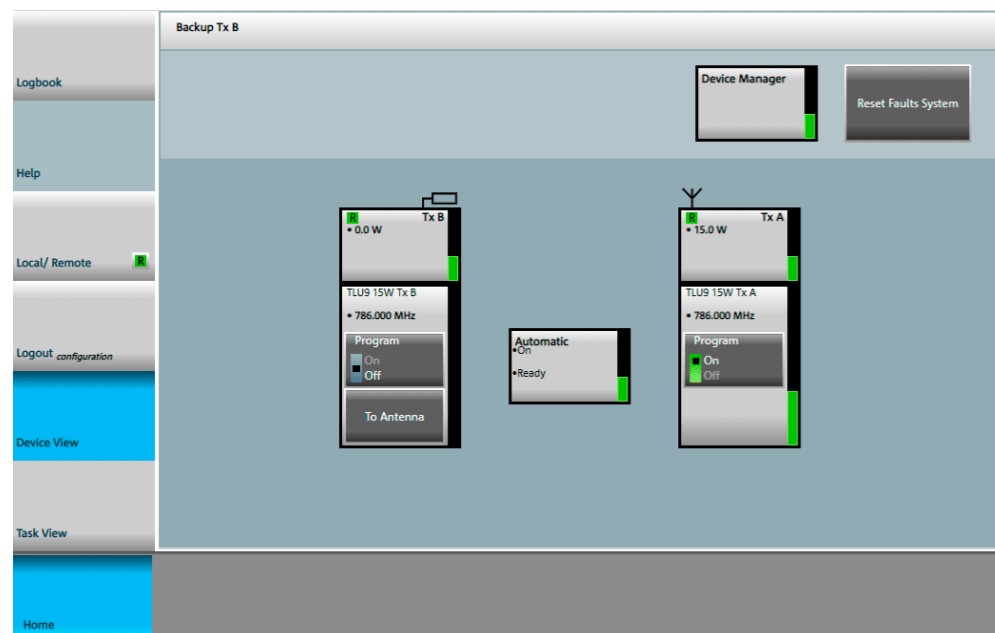

SPECIFICATIONS

Specifications		
Frequency range	VHF band III	170 MHz to 240 MHz
	UHF band IV/V	470 MHz to 790 MHz (790 MHz to 802 MHz on request)
Digital TV		
Standards	transmitter	DVB-T, DVB-T2, ISDB-T _B , ATSC 1.0/ATSC 3.0, DTMB
	gap filler	DVB-T, DVB-T2, ISDB-T _B , DTMB
Channel bandwidth	DVB-T	5/6/7/8 MHz
	DVB-T2	1.7/5/6/7/8 MHz
	ISDB-T/ISDB-T _B , DTMB	6 MHz/8 MHz
	ATSC	6 MHz
Transmitter inputs	DVB-T, DVB-T2, DTMB	2 × ASI (BNC, 75 Ω), 2 × TSoIP (Gigabit Ethernet)
	ISDB-T/ISDB-T _B	2 × BTS (BNC, 75 Ω), 2 × TSoIP (Gigabit Ethernet)
	ATSC	2 × SMPTE 310M or 2 × ASI (BNC, 75 Ω), 2 × TSoIP (Gigabit Ethernet)
	DVB-S/DVB-S2 signal feeding (optional)	2 × F (75 Ω)
Retransmitter/translator input	DVB-T, DVB-T2, ATSC 1.0	1 × RF (BNC, 50 Ω), (170 MHz to 254 MHz and 470 MHz to 790 MHz)
Gap filler input	DVB-T, DVB-T2, ISDB-T _B	1 × RF (BNC, 50 Ω), (470 MHz to 790 MHz)
Digital radio		
Standards	transmitter	DAB, DAB+
Channel bandwidth	DAB, DAB+	1.536 MHz
Transmitter inputs	DAB, DAB+	2 × ETI (BNC, 75 Ω), 2 × EDI (Gigabit Ethernet)
Synchronization		
Reference frequency		10 MHz, 0.1 V to 5 V (V _{pp}) or TTL, BNC
Reference pulse		1PPS, TTL, BNC
GPS/GLONASS receiver sensitivity	optional for transmitter	-150 dBm (typ. -164 dBm), SMA
Integrated OCXO		bridges reference signal interruptions for up to 24 h
Operation		
Status panel with buttons and LEDs		local operation
Display unit with touchscreen	optional	local display and operation
Ethernet interface, RJ-45		web interface: local, remote
	optional	network management interface via SNMP
Parallel remote interface	optional	floating contacts for messages and commands
General data		
Supply voltage		100 V to 240 V ± 10%, 2 wires + PE (L1/N/PE), 50 Hz to 60 Hz ± 5%
Maximum installation altitude		3000 m above sea level (> 3000 m on request)
Operating temperature range		+1 ° to +45 °C
Relative humidity (max.)		95 %, non-condensing (indoors)
Immunity ¹⁾	to fast transients and bursts in line with IEC 61000-4-4	±2 kV (AC supply), ±1 kV (signal inputs)
	to surges in line with IEC 61000-4-5	symmetrical: ±1 kV (e.g. L-N), asymmetrical: ±2 kV (e.g. L-PE, N-PE)

¹⁾ To satisfy more stringent requirements, appropriate measures must be implemented at the transmitter site.

To comply with the applicable standards and limit values for the suppression of out-of-band emissions (and in the case of digital standards, also for maintaining the required shoulder distance), the transmitter may only be operated with suitable filters at the RF output.

Your local Rohde & Schwarz expert will help you find the best solution for your requirements.
To find your nearest Rohde & Schwarz representative, visit www.sales.rohde-schwarz.com

FROM PRESALES TO SERVICE. AT YOUR DOORSTEP.

The Rohde & Schwarz network in over 70 countries ensures optimum on-site support by highly qualified experts.

User risks are reduced to a minimum at all project stages:

- ▶ Solution finding/purchase
- ▶ Technical startup/application development/integration
- ▶ Training
- ▶ Operation/calibration/repair

The R&S®TLx9 Low-Power VHF/UHF Transmitter and GapFiller family for digital TV and DAB+ applications is the most reliable transmitter and gap filler series on the market. To ensure operational readiness of your systems and plannable budgeting for operating expenses, Rohde & Schwarz offers service level agreements (SLA) for your systems, allowing you to concentrate on your core business. We take care of the service you need to succeed with your business model.

For details, please contact your local Rohde & Schwarz representative.



Service that adds value

- ▶ Worldwide
- ▶ Local and personalized
- ▶ Customized and flexible
- ▶ Uncompromising quality
- ▶ Long-term dependability

Rohde & Schwarz

The Rohde & Schwarz technology group is among the trailblazers when it comes to paving the way for a safer and connected world with its leading solutions in test & measurement, technology systems and networks & cybersecurity. Founded more than 85 years ago, the group is a reliable partner for industry and government customers around the globe. The independent company is headquartered in Munich, Germany and has an extensive sales and service network with locations in more than 70 countries.

Sustainable product design

- ▶ Environmental compatibility and eco-footprint
- ▶ Energy efficiency and low emissions
- ▶ Longevity and optimized total cost of ownership

Certified Quality Management
ISO 9001

Certified Environmental Management
ISO 14001



绿测科技有限公司

广州总部：广州市番禺区陈边村金欧大道83号江潮创意园A栋208室
深圳分公司：深圳市龙华区龙华街道 油松社区东环一路1号耀丰通工业园1-2栋2栋
607 南宁分公司：广西自由贸易试验区南宁片区五象大道401号五象航洋城1号楼3519
号 广州分公司：广州市南沙区凤凰大道89号中国铁建·凤凰广场B栋1201房
电话：020-2204 2442
传真：020-8067 2851
邮箱：Sales@greentest.com.cn
官网：www.greentest.com.cn



微信视频号



绿测科技订阅号



绿测工场服务号